

# HANOLA

Art.-Nr.

404 238  
404 239  
404 240  
404 241

1560  
836  
350  
mm

1/10  
VO  
50-2024

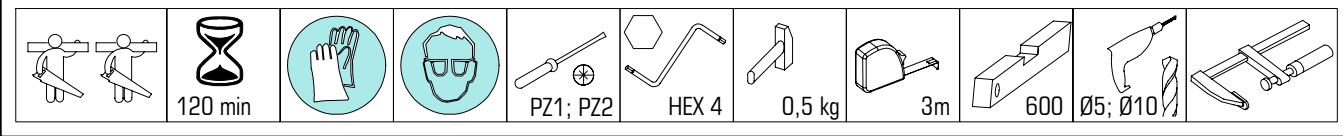



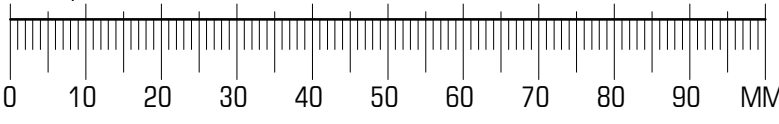
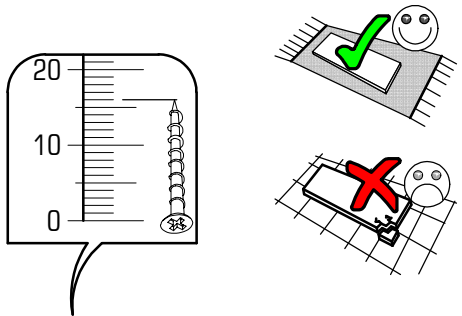
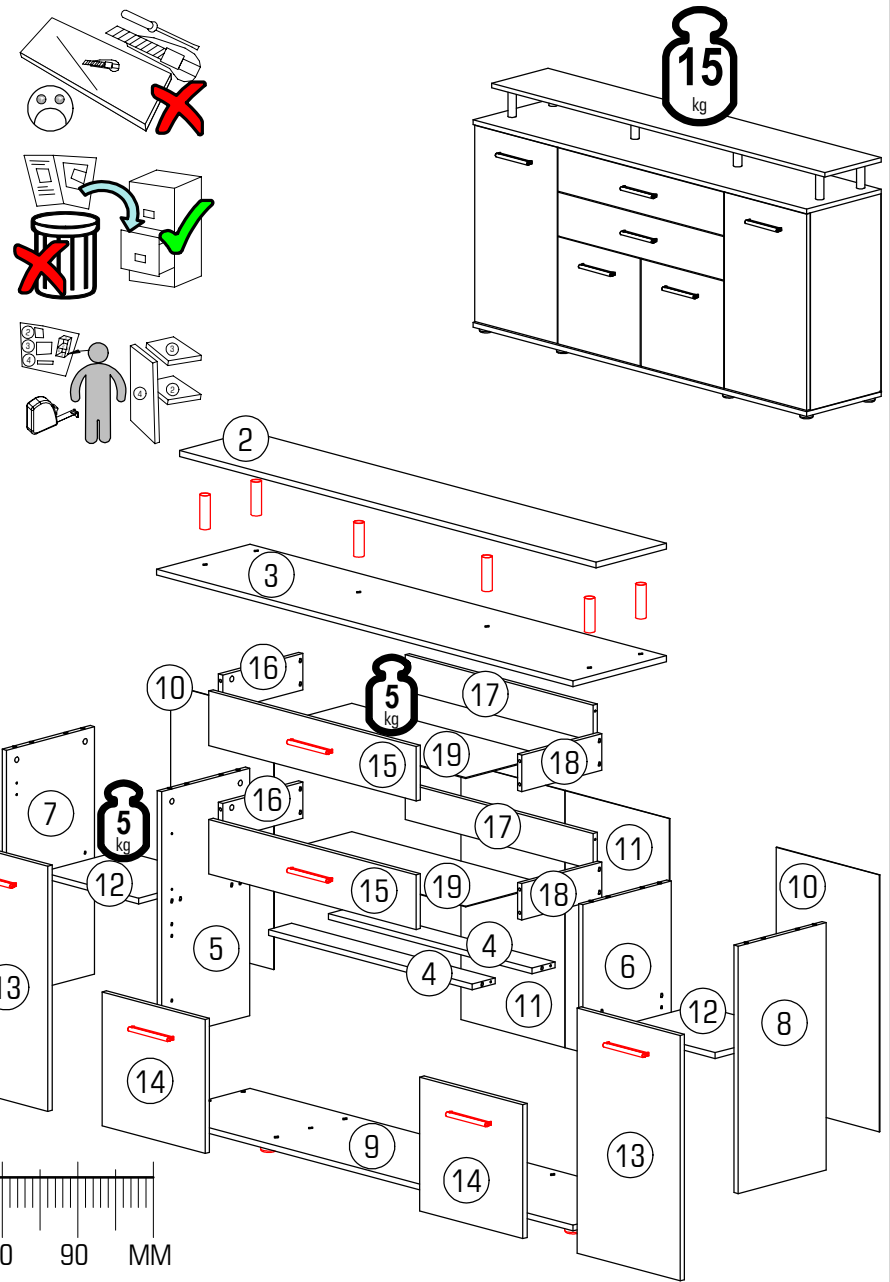

ID	ID	Part	Qty	Box
18853	②	1560*264*16	1x	1/2
18854	③	1560*350*16	1x	1/2
18855	④	762*86*16	2x	1/2
18856	⑤	680*330*16	1x	1/2
18857	⑥	680*330*16	1x	1/2
18858	⑦	680*330*16	1x	1/2
18859	⑧	680*330*16	1x	1/2
18860	⑨	1560*350*16	1x	1/2
18861	⑩	706*386*3	2x	2/2
18862	⑪	706*390*3	2x	2/2
18863	⑫	365*300*16	2x	2/2
18864	⑬	386*674*16	2x	2/2
18865	⑭	386*368*16	2x	2/2
18866	⑮	776*150*16	2x	2/2
18819	⑯	300*100*16	2x	2/2
18867	⑰	704*100*16	2x	2/2
18822	⑱	300*100*16	2x	2/2
18868	⑲	306*732*3	2x	1/2

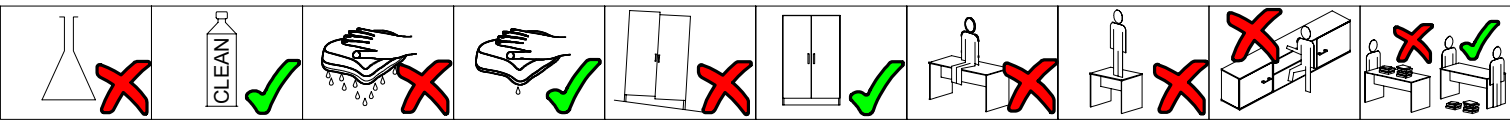

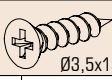

	21102,00 A 50x Ø1,6x20	22256,00 B 2x Ø5,0x70	22250,00 C 8x Ø4x25	22243,00 D 32x Ø3,5x15	22244,01 E 14x Ø3,5x16	22300,00 F 24x Ø7x50	22280,00 G 12x Ø4x30	24091,00 H 6x Ø10x11	
22705,00 J 8x Ø6,8x8	24101,00 K 2x Ø10	27000,00 L 12x Ø8x30	31103,00 M 2x	35101,01 N 8x	70013,01 P1 16x Ø15x13	P2 16x	70021,01 Q 16x	36002,07 R1 4x	36002,07 R2 4x
32030,00 S 6x L=150	30080,00 T 8x Ø44x15	33003,00 U1 2x L=300	33003,00 U2 2x L=300	60036,01 V1 6x L=93	22609,00 V3 6x HEX 4 M6x120	36013,02 W1 4x	36013,02 W2 4x	24008,00 X1 12x	22236,00 X2 12x

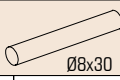
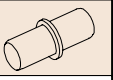

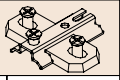
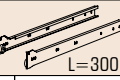
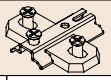

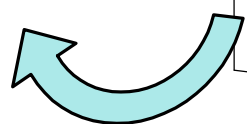
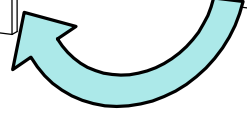
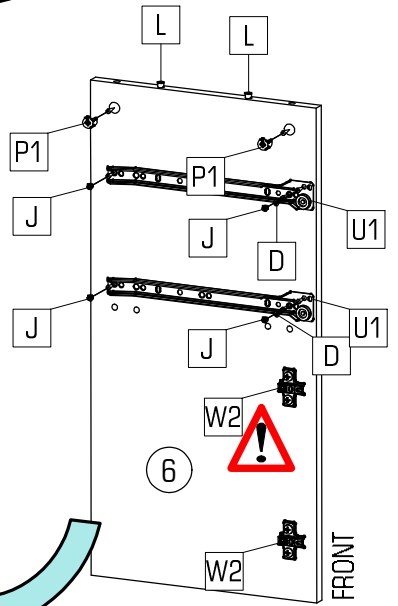
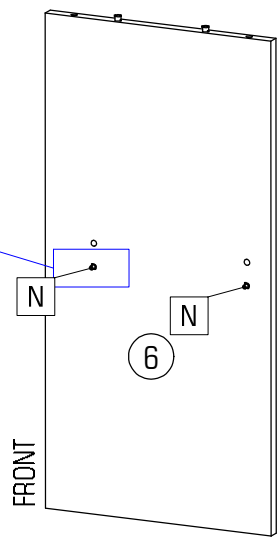
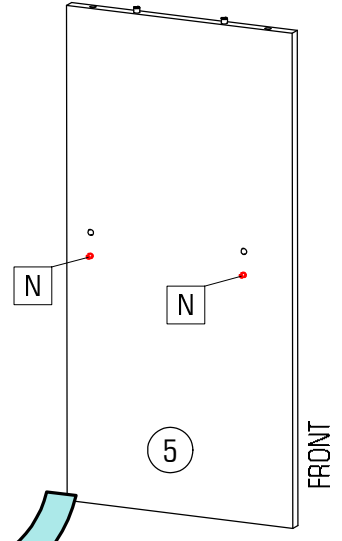
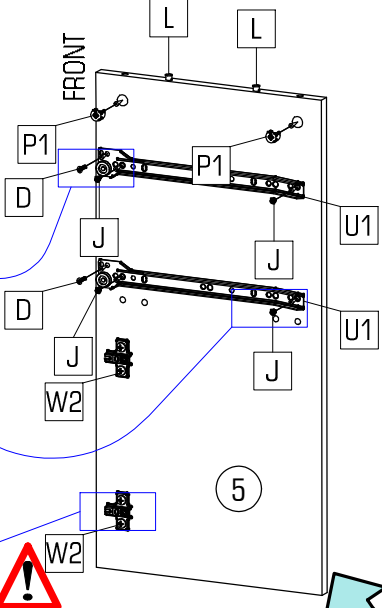
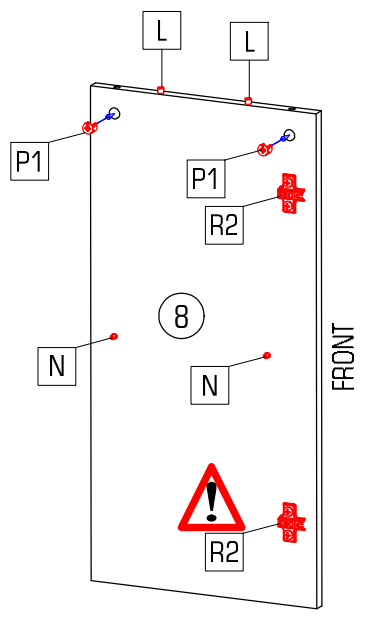
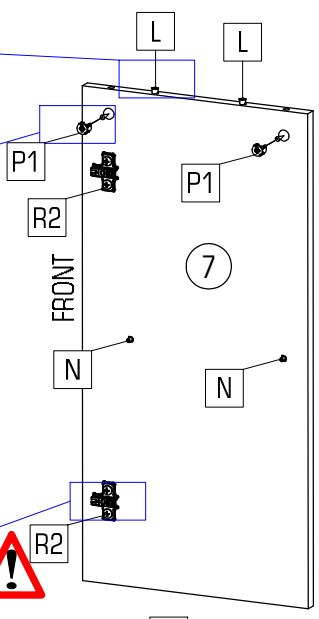
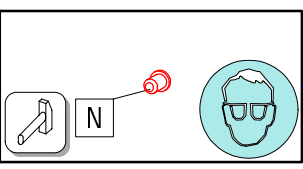
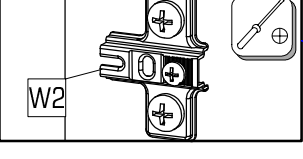
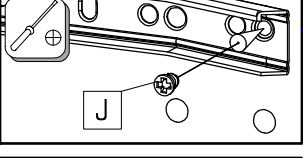
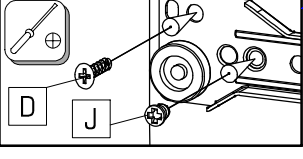
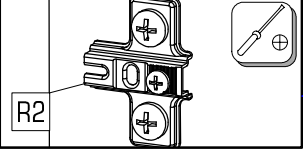
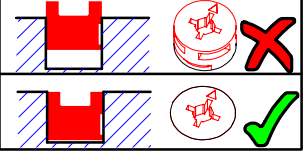
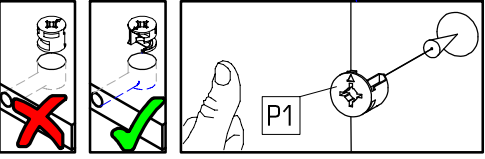
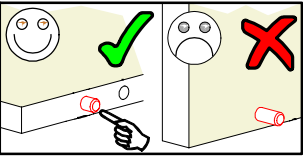
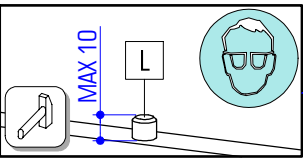

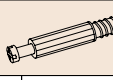

# 2/10 HANOLA

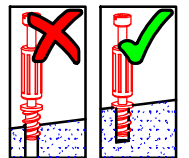
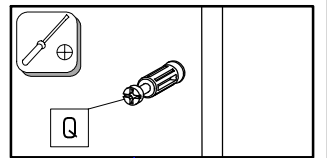
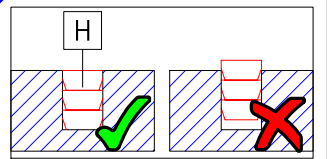
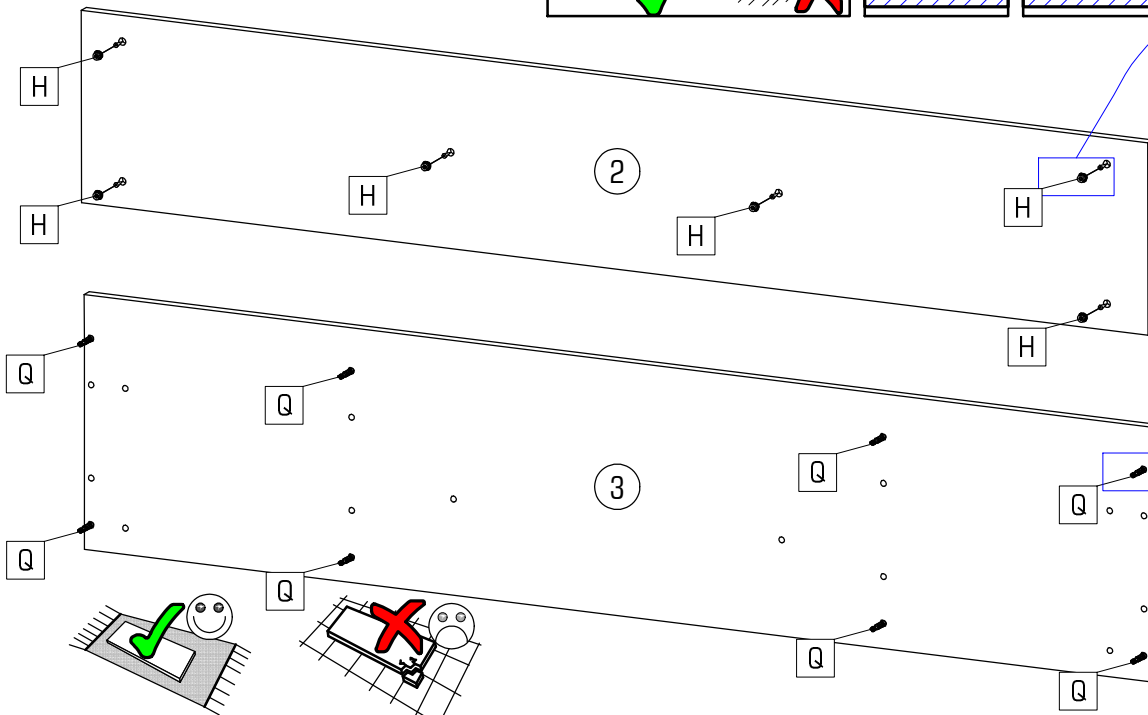
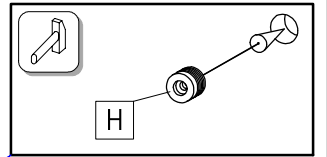
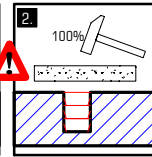
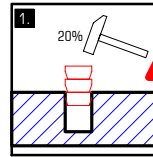
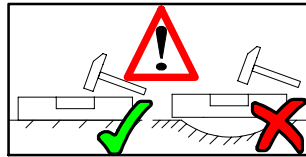
							
D	J	L	N	P1	R2	U1	W2
4x	8x	8x	8x	8x	4x	2x	4x

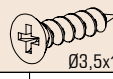
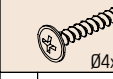
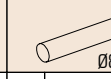

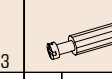

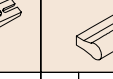
	
H 6x	Q 8x



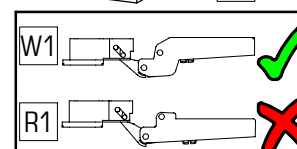
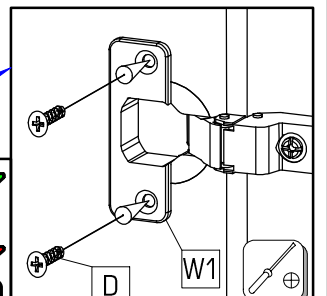
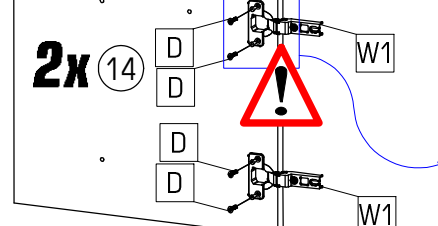
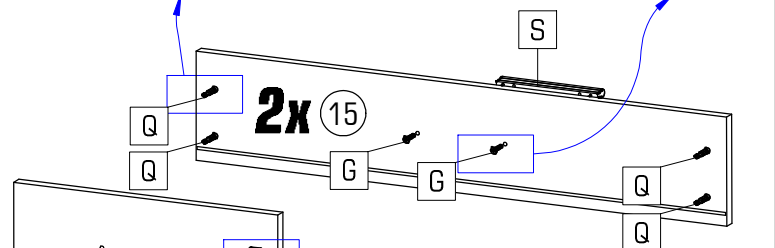
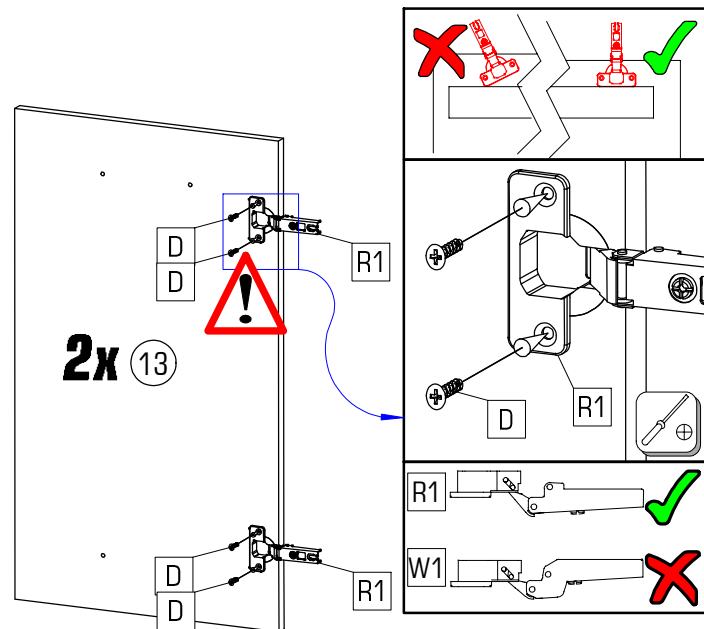
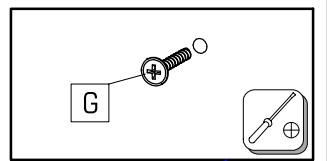
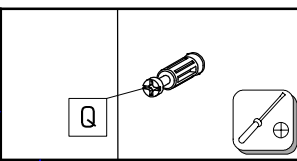
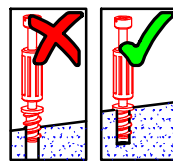
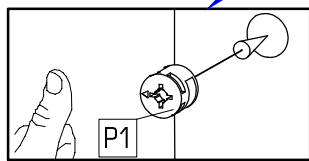
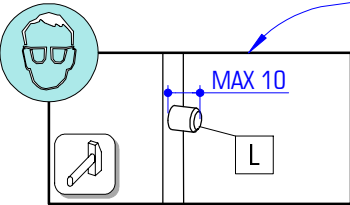
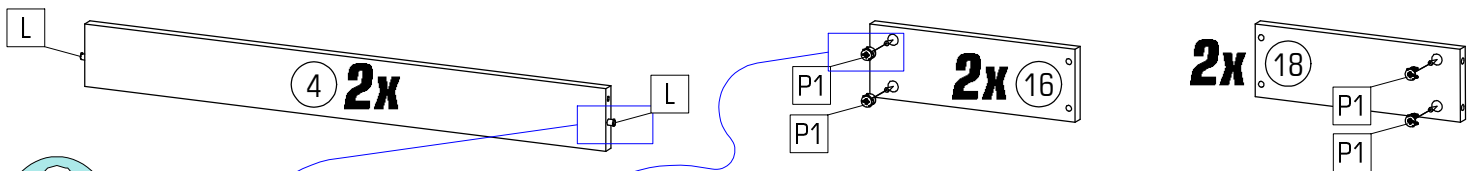

							
D 16x	G 4x	L 4x	P1 8x	Q 8x	R1 4x	S L=150	W1 4x



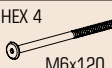

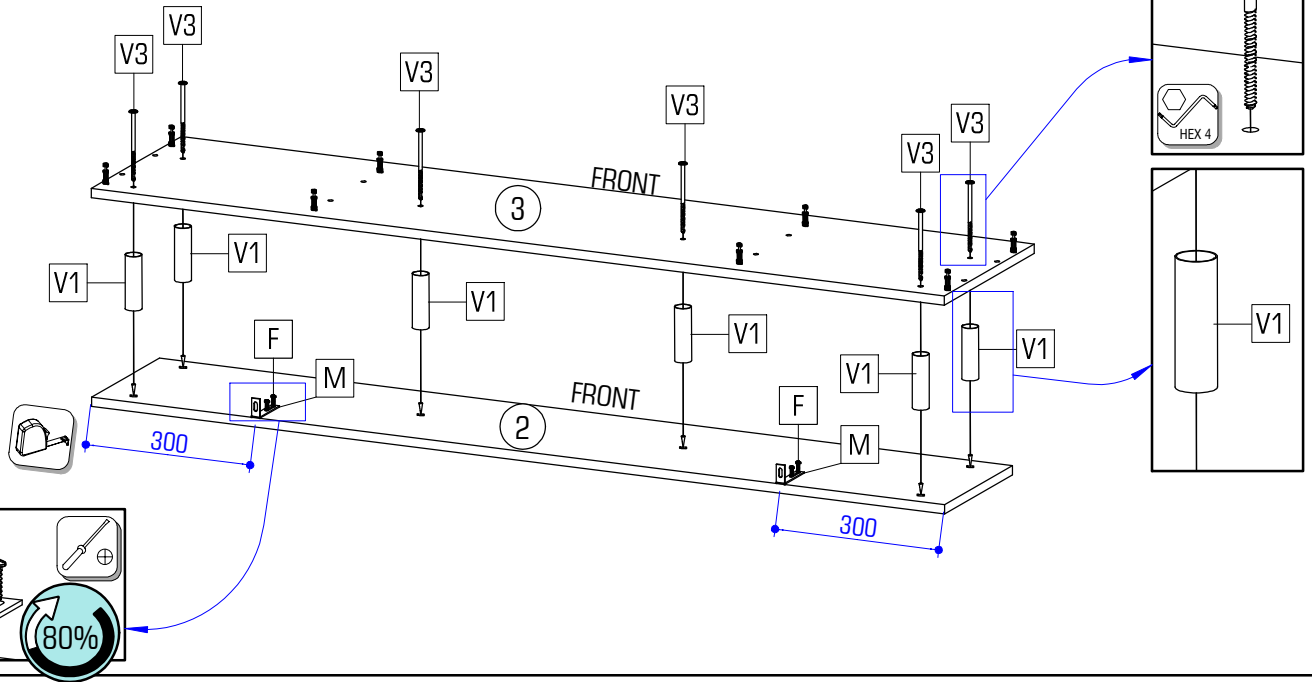
# 4/10 HANOLA

			
Ø3,5x16	L=93	HEX 4	M6x120
E 4x	M 2x	V1 6x	V3 6x



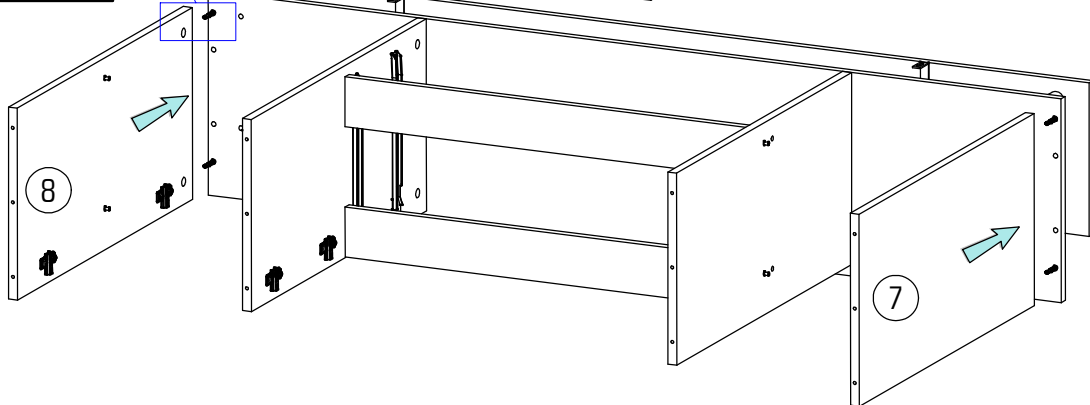
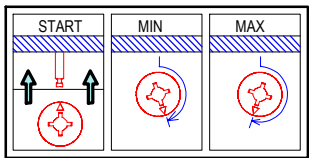
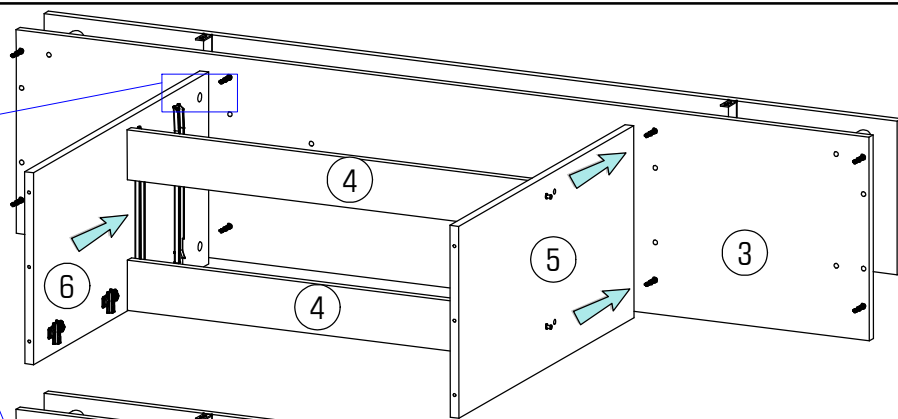
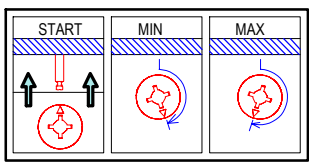
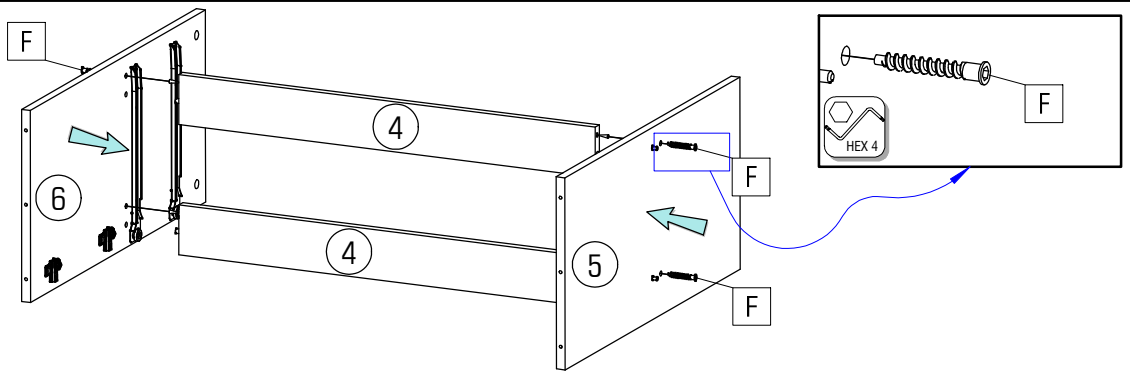



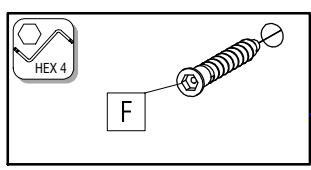
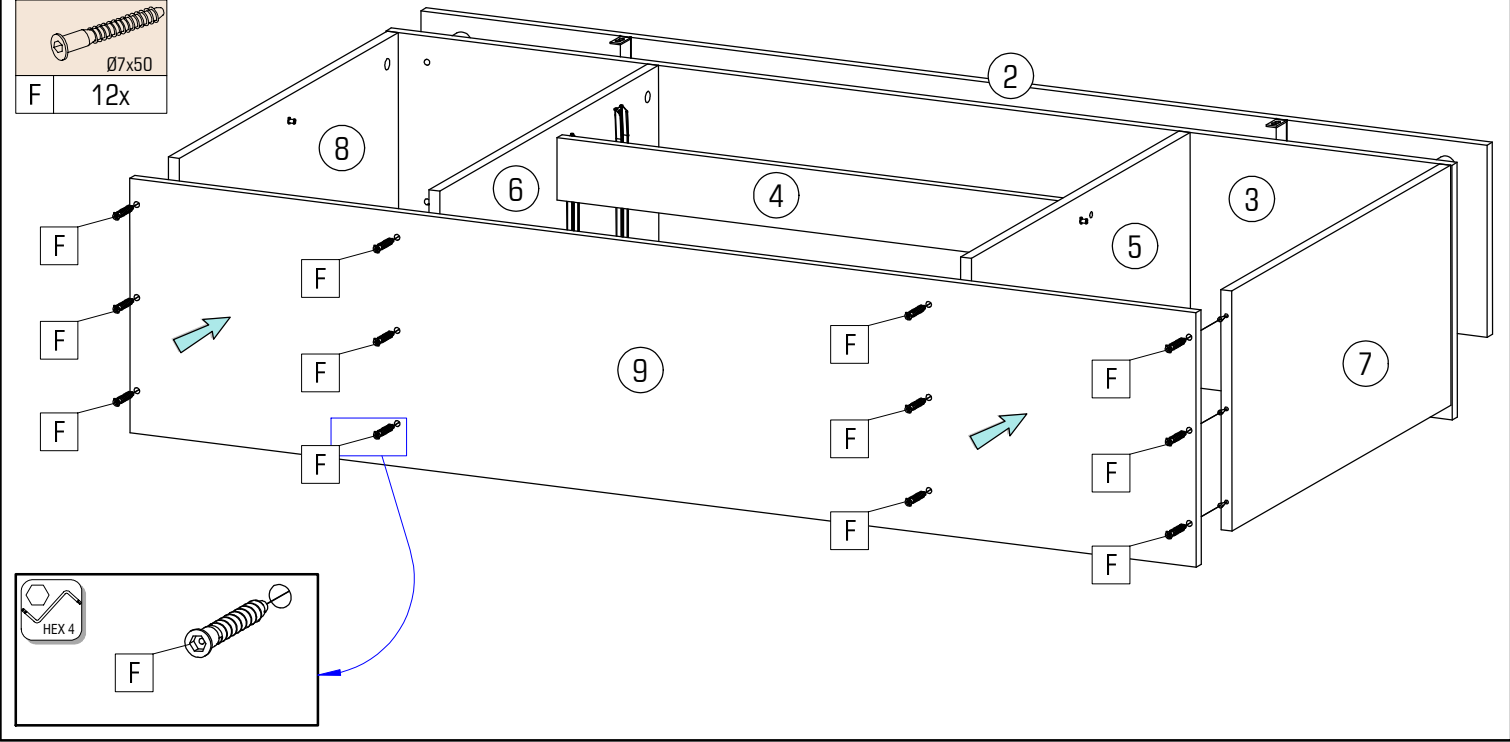

Ø7x50
F 4x

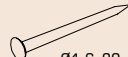

	Ø7x50
F	12x

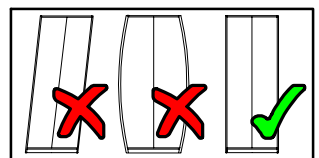
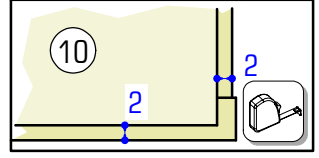
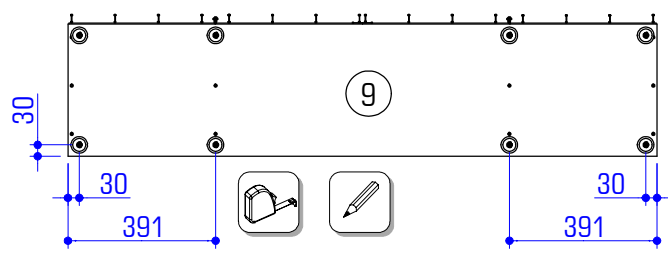
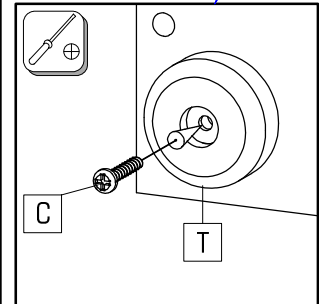
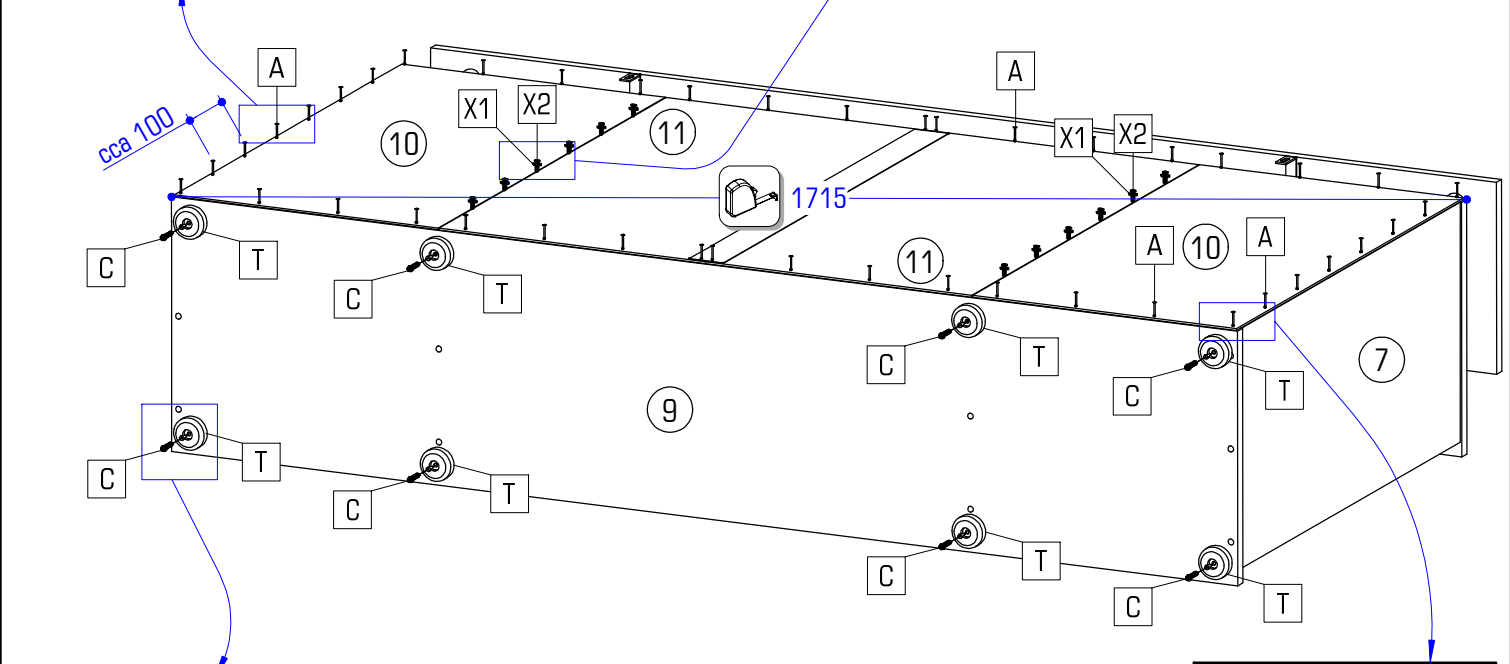
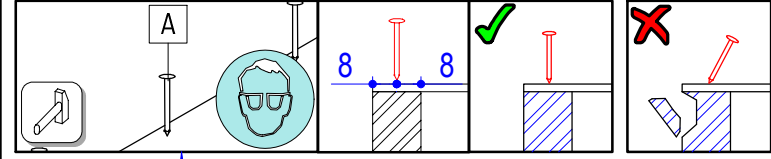
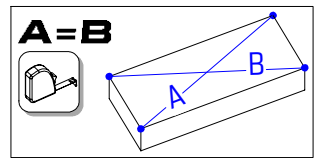
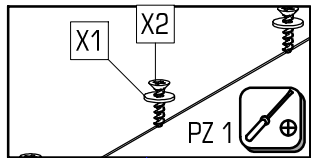

				
A 50x	C 8x	T 8x	X1 12x	X2 12x



# 6/10 HANOLA



**PL** Uwaga! Ścianę należy sprawdzić przed montażem. Dołączone uniwersalne kolki rozporowe są odpowiednie tylko do stosowania w mocnych murach, takich jak beton lub cegła. Nie rób za pomocą kółków ozporowych murowanych, takich jak pustak, lekka kostka, powierzchnie takie jak płyty gipsowo-kartonowe lub inne systemy ram. Jeśli dotyczy, muszą to być określone kolki rozporowe być użytych! Są one dostępne w specjalistycznym sklepie niezgodność, producent / sprzedawca lub importer nie ponoszą odpowiedzialności.

**RO** Prudență! Zidul trebuie examinat înainte de asamblare prizele de perete sunt adecvate numai pentru utilizarea în zidărie fermă, cum ar fi betonul bloc sau cărămidă. Nu folosiți zidăria zidurilor de perete, cum ar fi cărămida goală, blocul ușor, suprafețe cum ar fi gips-carton sau altă încadrare sisteme. Dacă este cazul, trebuie folosite anumite prize de perete! Acestea sunt disponibile la un magazin specializat (magazin de hardware) . În caz de nerespectare, producătorul / vânzătorul cu amănuntul sau importatorul nu își asumă răspunderea.

**SI** Pozor! Pred montažo preverite stanje stene. Priloženi univerzalni mozniki so izključno samo za uporabo na čvrstem zidovju, kot sta beton in opeka. Stenski mozniki se ne smejo uporabljati pri zidovju kot so votlina opeke, zidaki za lahko gradnjo, mavčne plošče ali druge okvirne gradnje. Pri teh zidovjih morate v danih primerih uporabljati posebne moznike. Ti so na voljo v specializiranih trgovinah (trgovinah z gradbenim materialom) Pri upoštevanju se s strani proizvajalca/trgovca in uvoznika ne prevzame jamstvo.

**DE** Achtung! Die Wandbeschaffenheit ist vor der Montage unbedingt zu prüfen. Die beigelegten Universaldübel sind ausschließlich nur zur Verwendung für festes Mauerwerk wie Beton/Ziegel. Die Mauerdübel dürfen nicht bei Mauerwerk wie Hohlraumziegel, Leichtbausteinen, Gipskartonplatte oder anderer Rahmenbauweise verwendet werden. Bei diesen Mauerwerken sind gegebenenfalls Spezialdübel zu verwenden! Diese sind in einem Fachgeschäft erhältlich. Bei Nicht Einhaltung wird seitens Produzenten/Händler und Importeur keine Haftung übernommen.

**HR** Pažnja! Prije montaže obvezno provjerite svojstvo zida. Priložene univerzalne tiplje namijenjene su isključivo za masivne zidove od betona/opeke. Tiplje za masivne zidove ne smiju se koristiti za zidove kao npr šupljina opeka laki sastavni elementi, gips-kartonske ploče ili drugi modularni načini gradnje. Za te zidove potrebne su eventualno specijalne tiplje! Iste su dostupne u specijaliziranim trgovinama građevinskim materijalom. U slučaju nepridržavanja prethodno navedenih napomena, proizvođač/trgovac i uvoznik ne preuzimaju odgovornost!

**HU** Vigyázat! Szerelés előtt a fal felületét feltétlenül vizsgálja meg. A mellékelt univerzális tiplik kizárólag stabil falazathoz használható mint például beton/tégla. A fal tiplje nem használható könnyű építőkövekhez, üreg tégla, gipskarton lapokhoz vagy más fázvas építőanyagokhoz. Ezekhez a fal felületéhez csak speciális tiplik használhatóak, melyek szaküzletekben (barkácsruházakban) beszerezhetőek. Fentiek figyelmen kívül hagyása esetén a gyártó/kereskedő vagy forgalmazó nem vállal felelősséget.

**EN** Caution! The wall must be examined before assembly. The included universal wall plugs are only suitable for using in firm masonry such as concrete block or brick. Do not use the wall plugs masonry such as hollow brick, lightweight block, surfaces such as gypsum plasterboard or other framing systems. If applicable, particular wall plugs must be used! These are available at a specialised store (hardware store). In case of non-compliance, the manufacturer/retailer or importer do not assume liability.

**CZ** Upozornění! Před montáží je nutné zkontrolovat stav stěny. Priložené univerzální hmoždinky jsou určeny pouze k použití pro pevné zdivo jako beton/cihly. Hmoždinky do zádi se nesmí používat u dutinová cihla, zdiva jako pórovitý stavební kámen, sádrokartonová deska nebo jiný měkký materiál. U těchto zdiv jsou nutné použít speciální hmoždinky! Jsou k dostání v speciálních prodejnách se stavebním materiálem. Při nedodržení těchto pokynů výrobce/prodejce a dovozce neručí za způsobené škody.

**SK** Upozornenie! Pevnosť steny sa musí pred montážou bezpodmienečne skontrolovať. Priložené univerzálne hmoždenky používajte jedine pre pevné murivo ako je betón/tehla. Hmoždenky sa nesmú používať v prípade ľahkého stavebného muriva, dutá tehla, Sádorkartónová doska, alebo iných konštrukcií rámu. U týchto stien je nutné použiť špeciálne hmoždenky! Tieto je možné dostať v špeciálnych predajniach so stavebným materiálom. Pri nedodržaní pokynov nepreberajú výrobca/predajca a dodávateľa zodpovednosť za vzniknuté škody.

Ø5,0x70	Ø10	
B 2x	K 2x	P2 8x

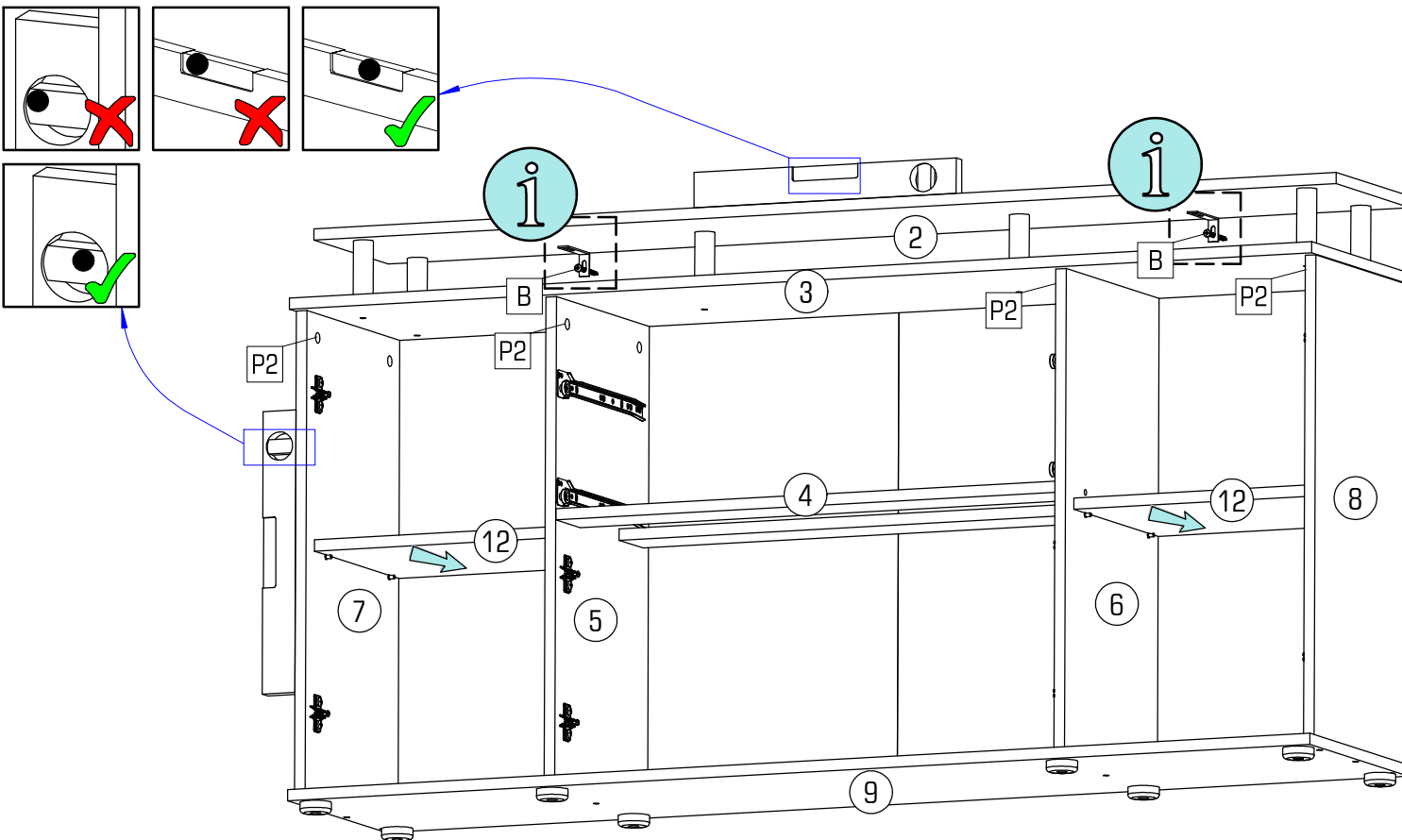
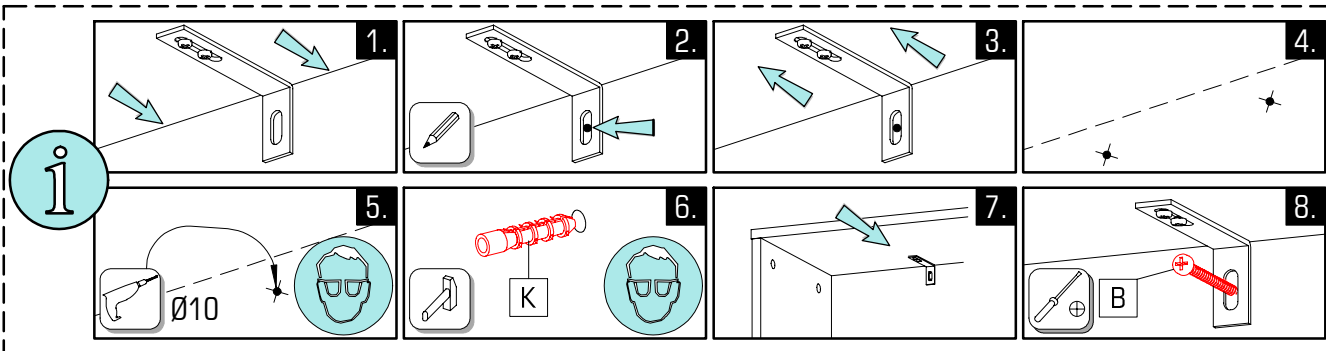
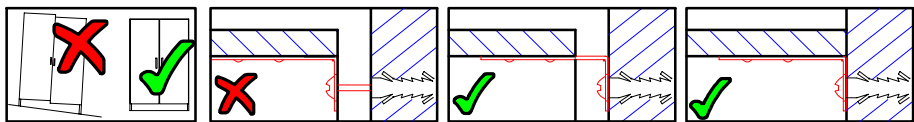

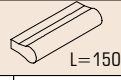
	
Ø4x30	L=150
G 4x	S 2x

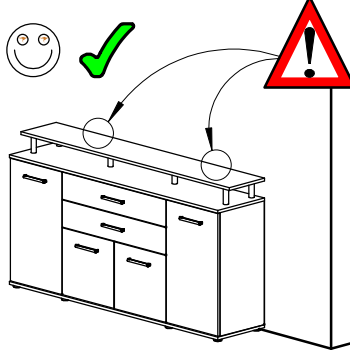

SK	VÝSTRAHA
CZ	VAROVÁNÍ
HR	UPOZORENIE
DE	WARNUNG
HU	FIGYELEM
PL	OSTRZEŻENIE
RO	AVERTIZARE
EN	WARNING
SI	OPOZORILO

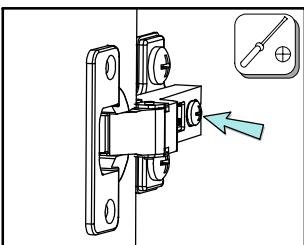
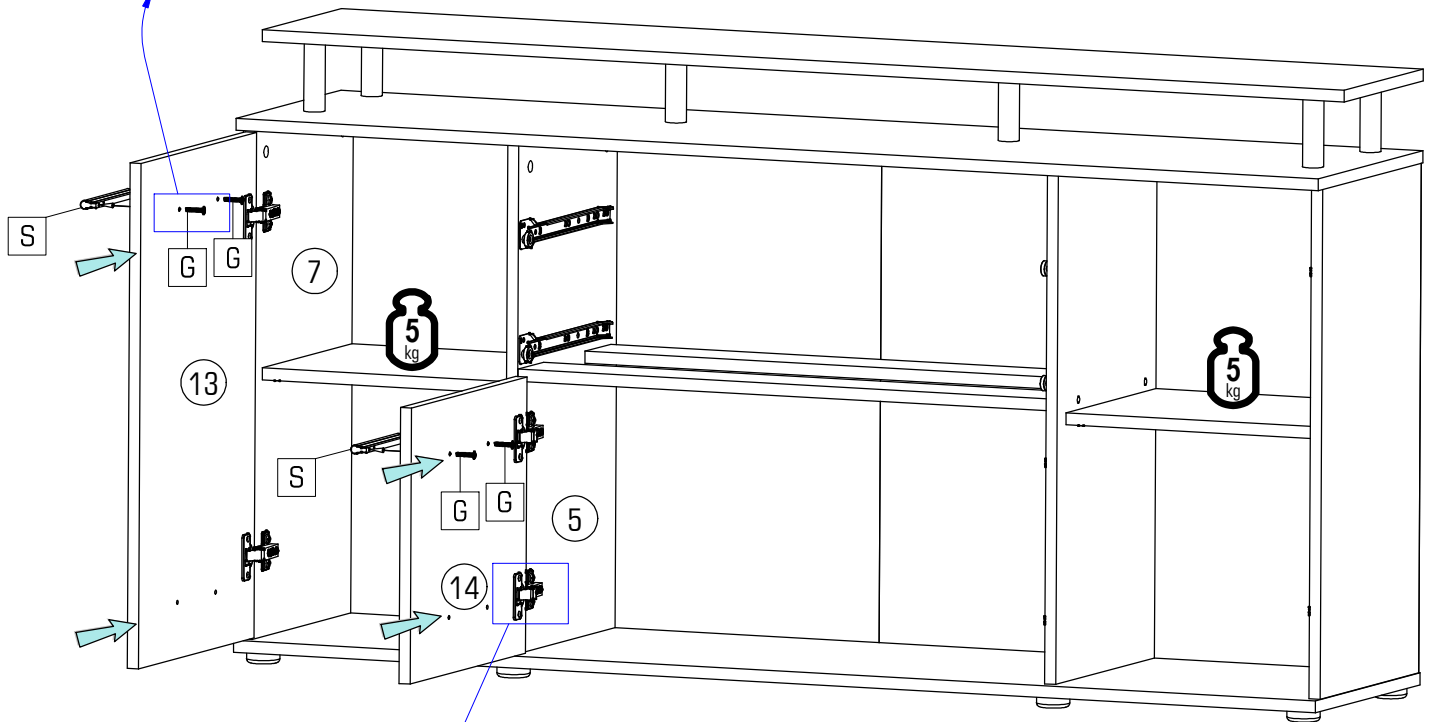
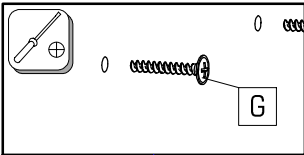
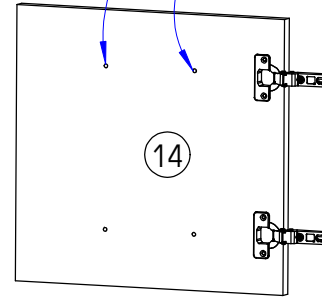
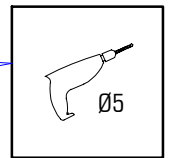
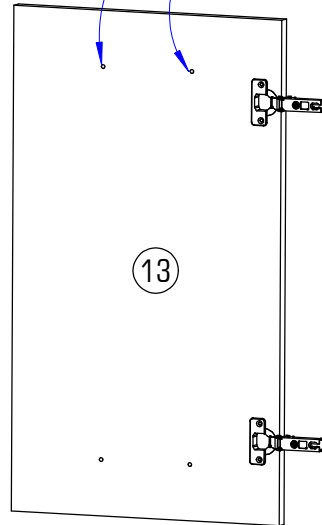
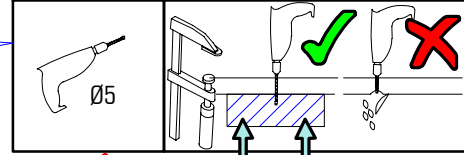
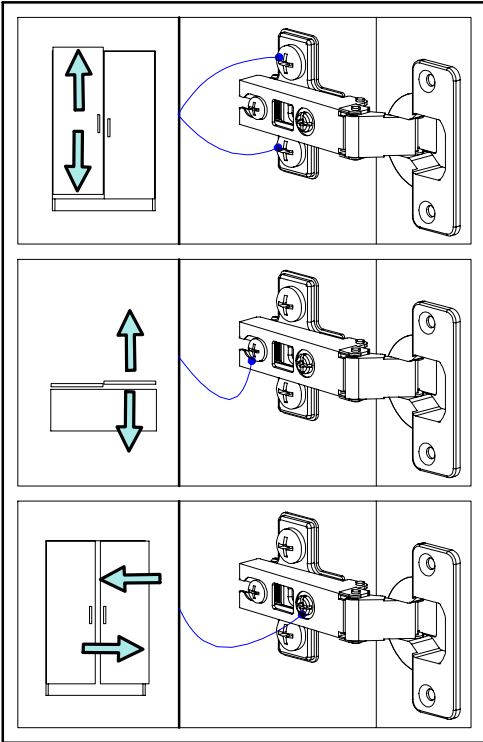





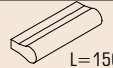

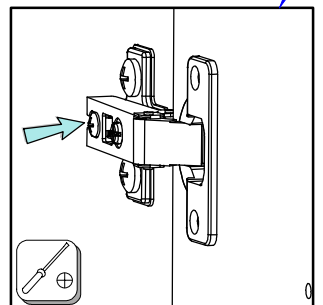
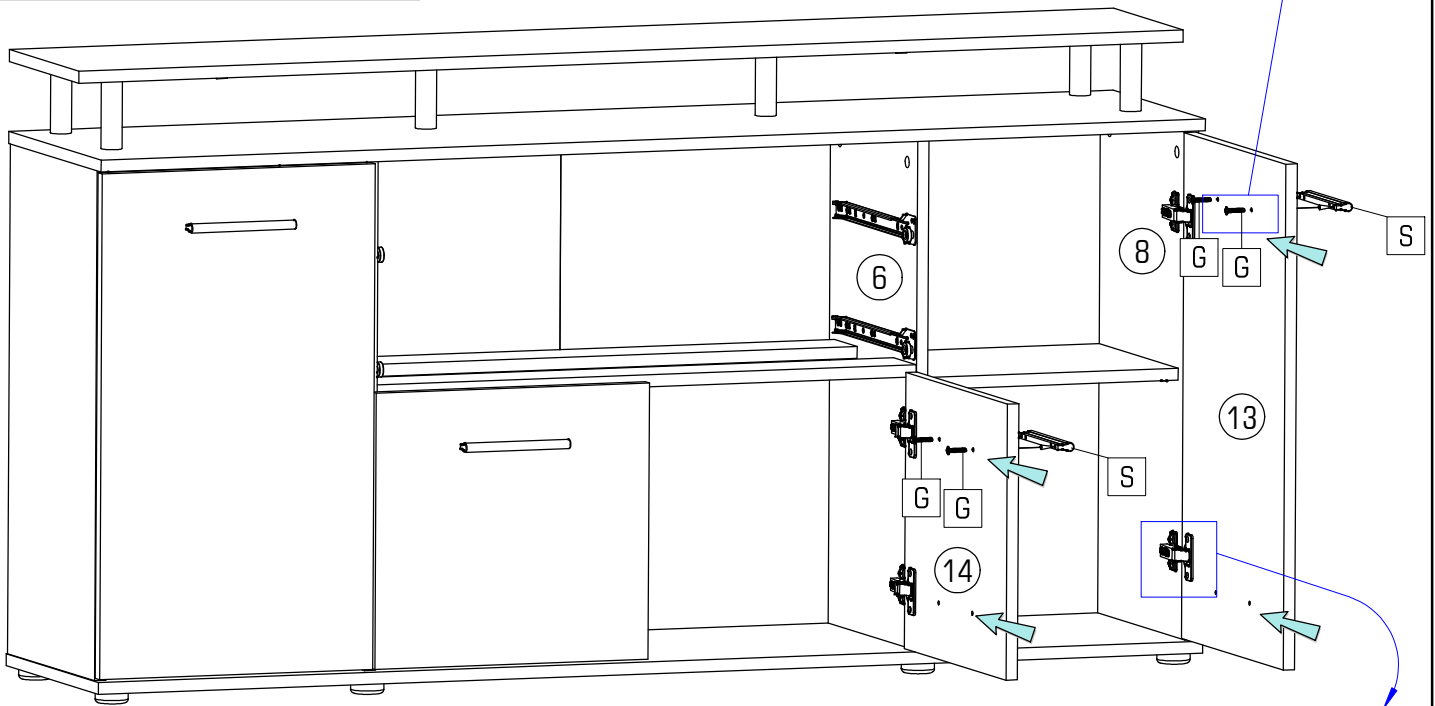
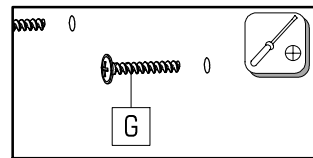
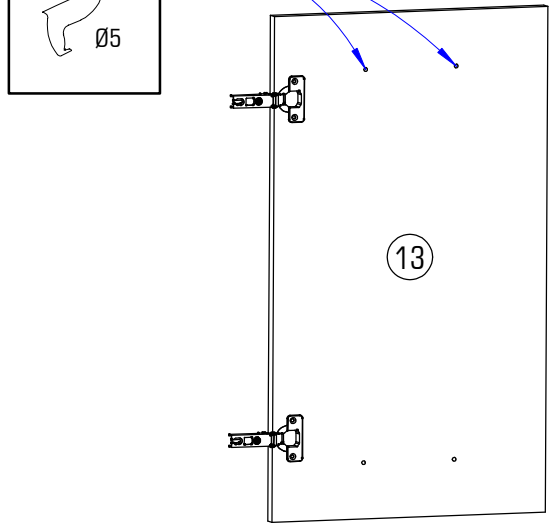
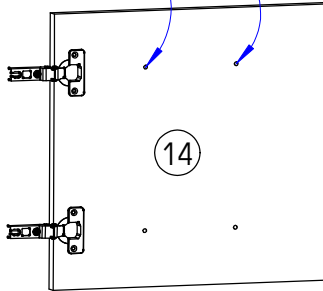
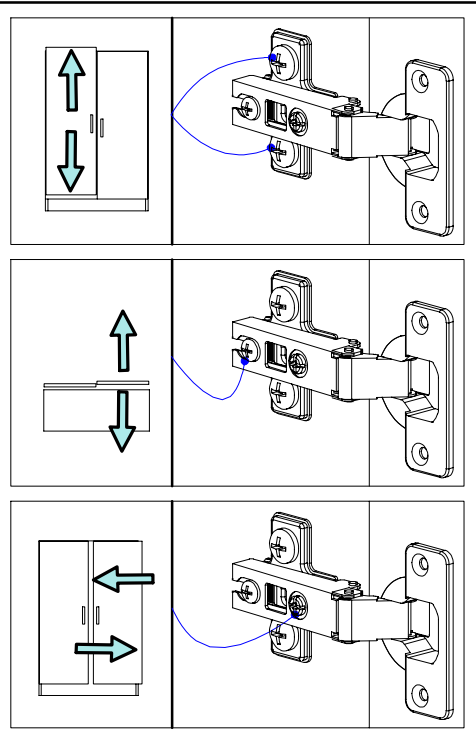
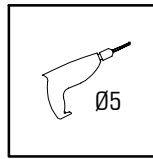
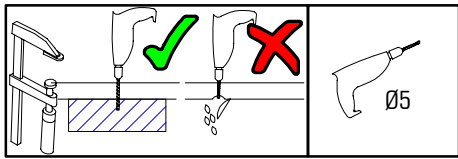
# 8/10 HANOLA

	
Ø4x25	L=150
G 4x	S 2x



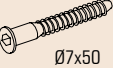

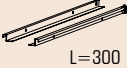
				
Ø3,5x15	Ø3,5x16	Ø7x50	HEX 4	L=300
D 12x	E 10x	F 8x	P2 8x	U2 2x

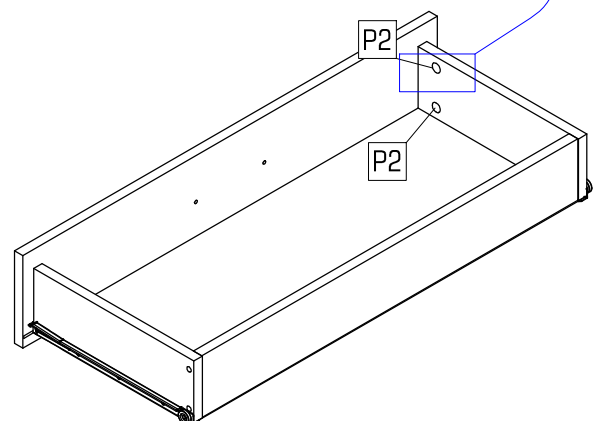
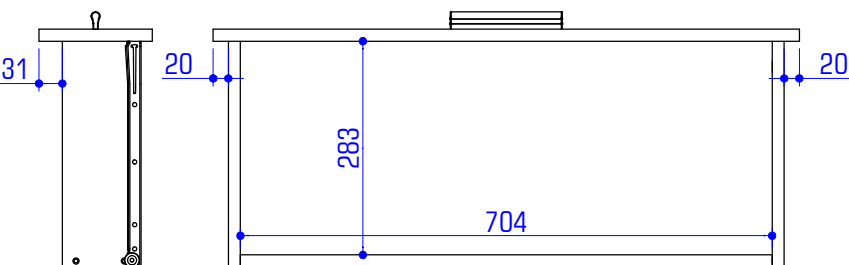
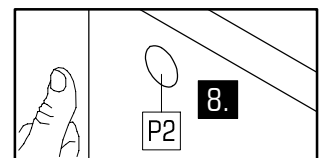
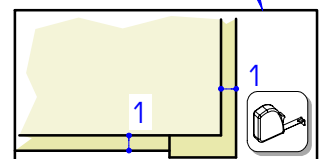
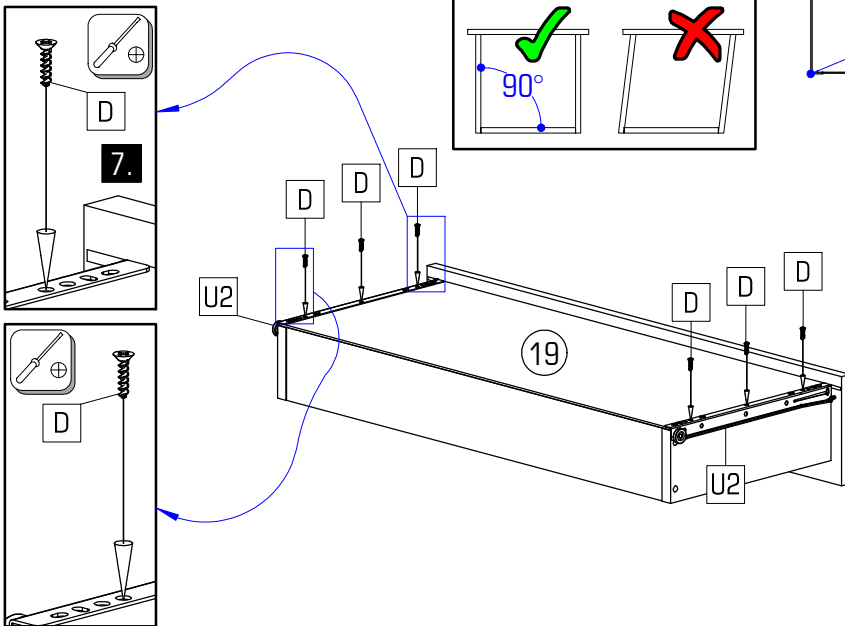
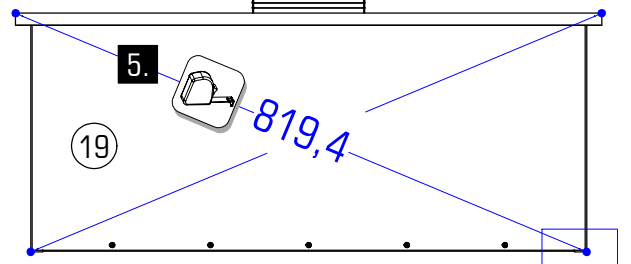
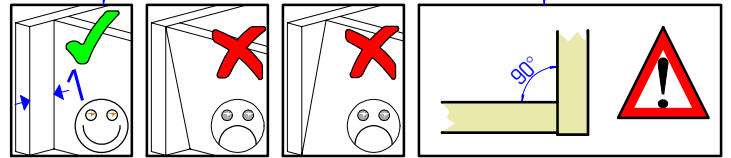
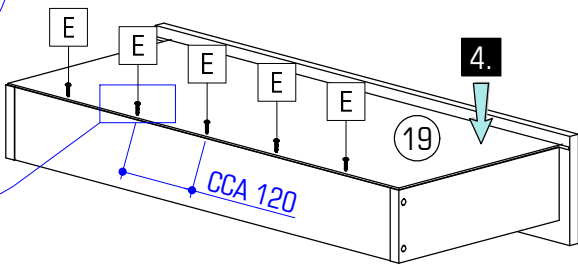
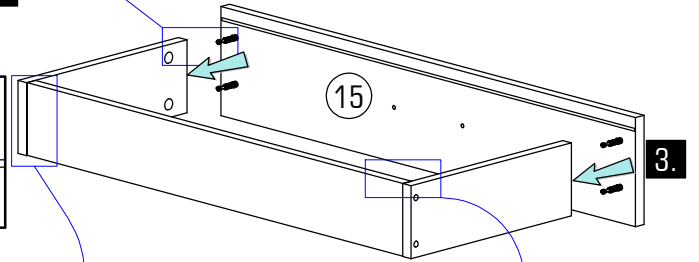
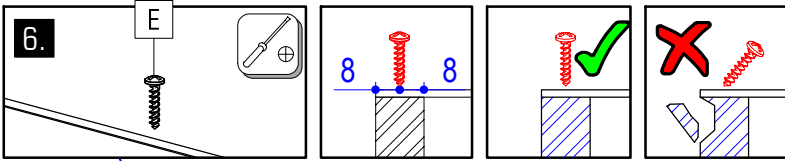
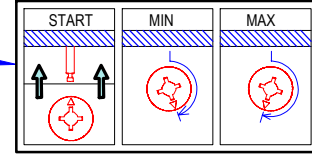
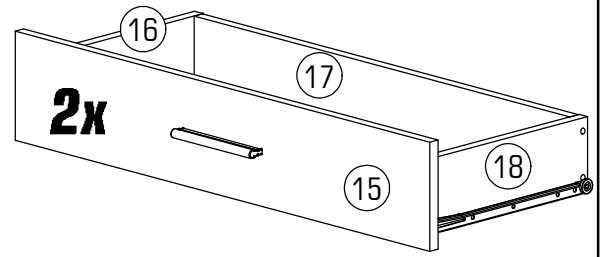
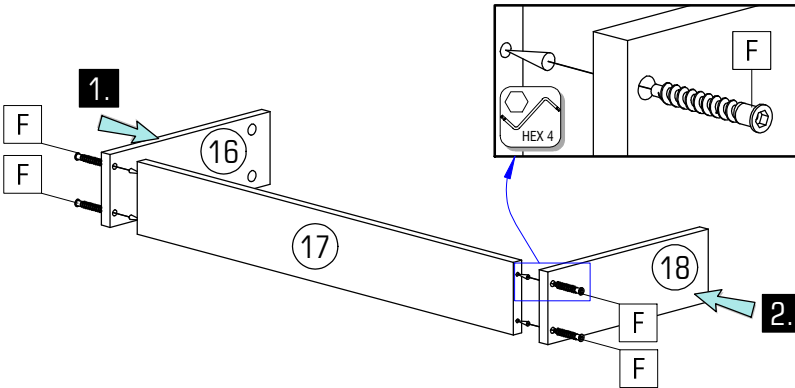

# 10/10 HANOLA

